

## Standards and regulation

CE, ENEC, Directive 2004/108/EC, 2006/95/EC, 2009/125/EC  
1194/2012/EU, 2011/65/EC, EN 60598, EN 62471, EN 55015,  
EN 61000, EN 62493, EN 61547.

## Other options available

Pre-cabling with quick connector  
Other RAL colours available on request

## Typical photometrical features

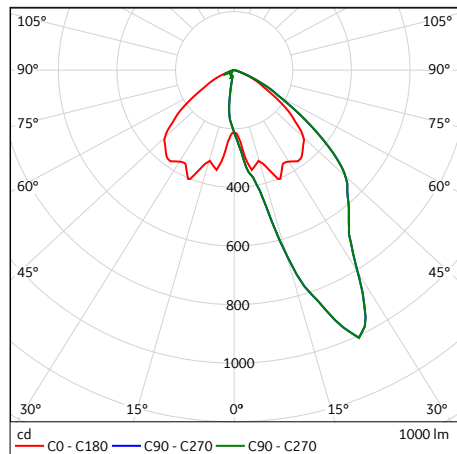

A25

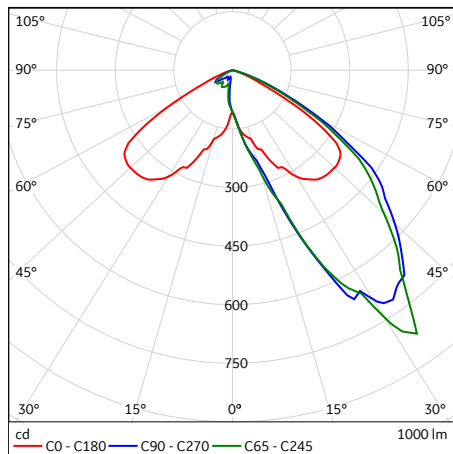

A35

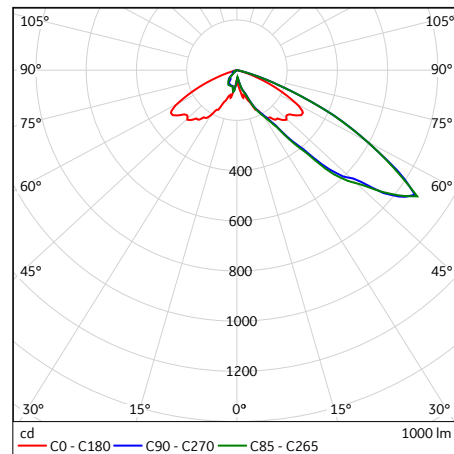

A55

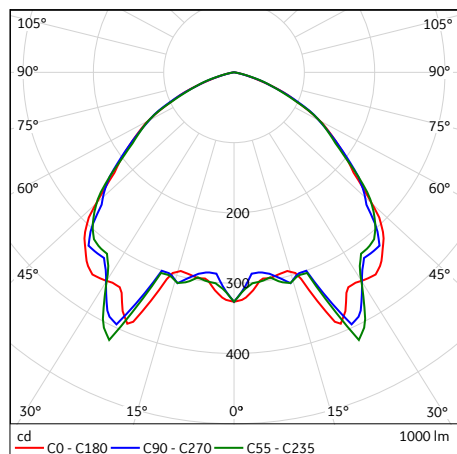

S25

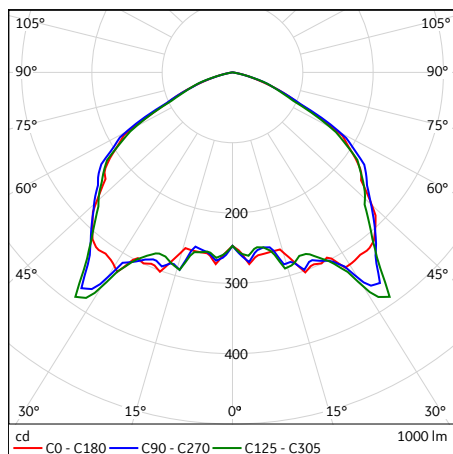

S35

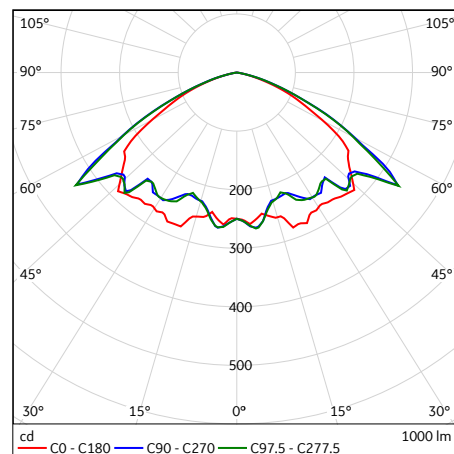

S55

## Dimensions (mm)

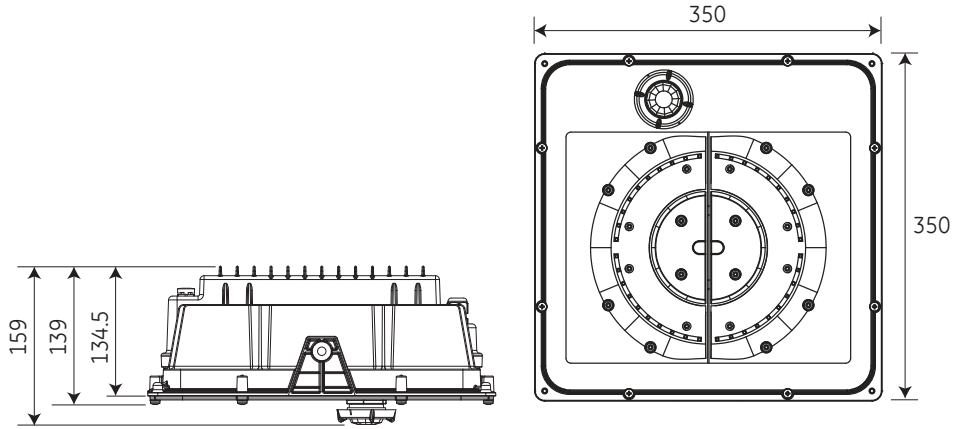

## Order logic

Name	Generation	Front Glass	Optics	Power (W)	CCT (K)	Control	Accessories	IEC Protection Classes	Precabbling	Mounting	Colour	
AMix	2	F-Flat Glass		39	3-3000 4-4000	N - No control	N - No Sensor	C1 - Class I	N- No precabbling	B - Bezel	R9003	
				40								
				S25- Symmetric 25°								54
				55								
				S35- Symmetric 35°								73
				74								
				S55- Symmetric 55°								77
				78								
				A25- Asymmetric 25°								106
				107								
				A35- Asymmetric 35°								125
				126								
				A55- Asymmetric 55°								143
				144								
155												
156												

**Example:** AMix/2/F/S25/107/4/D/S/C1/N/B

Sensor is not available with DALI control. Sensor has an IK07 rating.  
Bazel is sold as an accessory, SKU: 529723 ACOP BEZEL 390X390 AMix