

LED Luminaire

High Bay IP66 Range

Product information

This new IP66 rated LED fixture range is offering an exceptional mixture of value and performance for high bay applications requiring high water and impact resistance. The range includes wide variety of alternatives from color temperature, color rendering, beam angle and control systems to best optimize for customer requirements. Designed to replace high watt HID and T5/T8 LFL fixtures.

Applications

- Designed to meet luminance and illuminance requirements for High bay and Low bay applications where waterproofness and high impact resistance is specified

Housing

- Robust die-cast aluminum body with integrated cooling ribs and tempered glass window
- IP66 and IK08 rating

Ratings

- Temperature:
95W & 157W rated at -30°C to +55°C
190W rated at -30°C to +50°C
- Projected L80(10k) ≥ 61,000 Life Hours per IES TM-21

LED & Optical Assembly

- Utilizing the high performing ABV-series optical LED system to provide optimized illumination for open floor and racked aisles with photometric distributions of 55, 90 and 120 degrees
- Lumen packages up to 26,000 lumens
- 4000K & 5000K versions
- 70 & 80 CRI options

Order Logic

Product ID	Module	IP	Boards	CCT	Optic	Control	Options	Mounting	CE
HB	1	IP65 IP66	2 3 4	47 - 4000K; CRI70 48 - 4000K; CRI80 57 - 5000K; CRI70 58 - 5000K; CRI80	1 - 120° 5 - 55° 9 - 90°	D - Dali V - 1-10V	N - no sensor	ST - Standard	CE

Example: HB1IP662481VNSTCE

Mounting

- Two mounting options: Bracket kit for ceiling and wall mounting or Suspension holder kit.

Finish

- Painted white finish

Controls

- 95W & 190W with 1-10V dimming driver, but also can be used as fixed output option
- 157W with DALI control

Electrical

- 220-240V/50-60Hz
- System power factor is >90% and THD <20%

Photometric data

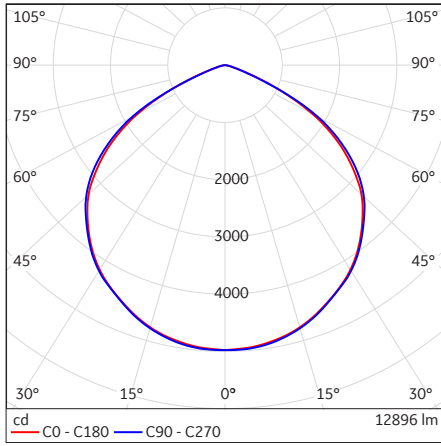

1-10V - 95W - 2 boards - 120°

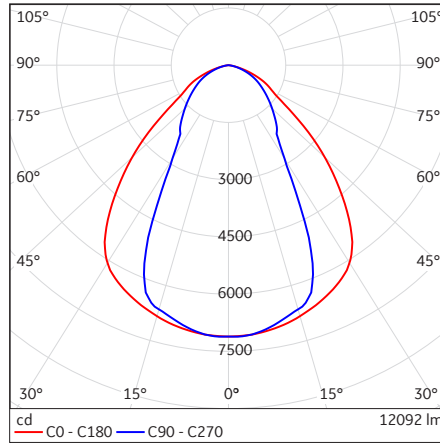

1-10V - 95W - 2 boards - 55°

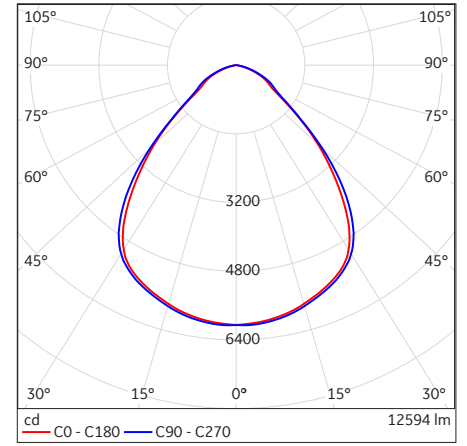

1-10V - 95W - 2 boards - 90°

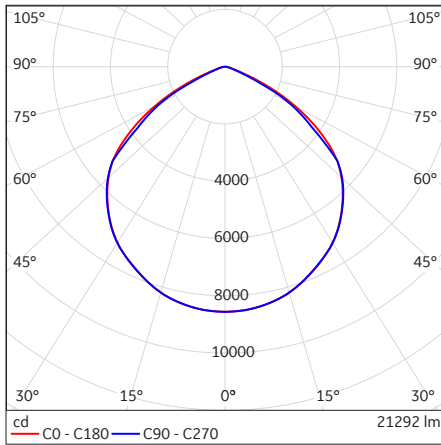

DALI - 157W - 3 boards - 120°

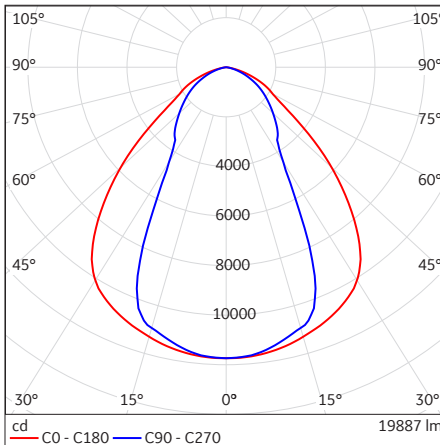

DALI - 157W - 3 boards - 55°

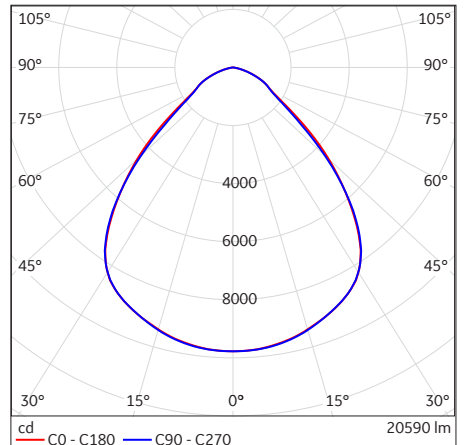

DALI - 157W - 3 boards - 90°

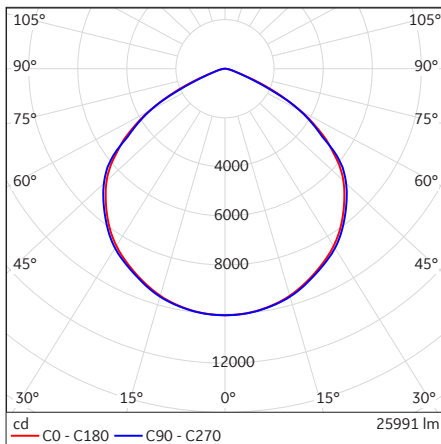

1-10V - 190W - 4 boards - 120°

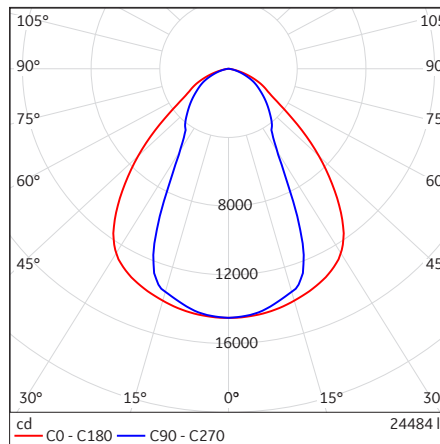

1-10V - 190W - 4 boards - 55°

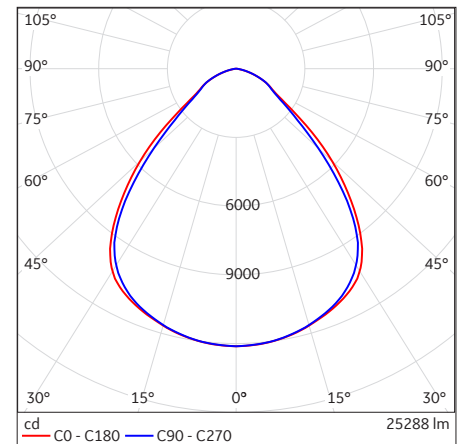

1-10V - 190W - 4 boards - 90°

Photometry is based on LM79.

OPTIC TYPE	MOUNTING HEIGHT	SPACE TYPE
120° Clear Optic (C1)	Any	Open Floor Plan
55° Clear Optic (C5)	Any	Low or High Bay Racked Aisles
90° Clear Optic (C9)	Any	Open Floor Plan

Photometric selection by application

This optical system enables LEDs to provide precise illumination where needed. Optics are designed for commercial & industrial applications where mounting height, fixture spacing & light levels help determine optical selection.

The following table outlines the photometric options and suggested application. Consult factory for specific project layouts.

Specification summary

Product Code	Product Description	Wattage (W)	CCT (K)	Lumen Output (lm)	System Efficiency (lm/W)	CRI (Ra)	Optics (°)	Sensor	Controls	IP
-	HB1IP662471VNSTCE	95	4000	12900	136	70	120	No	1-10V	IP66
-	HB1IP662475VNSTCE	95	4000	12100	127	70	55	No	1-10V	IP66
-	HB1IP662479VNSTCE	95	4000	12600	133	70	90	No	1-10V	IP66
-	HB1IP662481VNSTCE	95	4000	11800	124	80	120	No	1-10V	IP66
-	HB1IP662485VNSTCE	95	4000	11000	116	80	55	No	1-10V	IP66
-	HB1IP662489VNSTCE	95	4000	11400	120	80	90	No	1-10V	IP66
-	HB1IP662571VNSTCE	95	5000	12800	135	70	120	No	1-10V	IP66
-	HB1IP662575VNSTCE	95	5000	12000	126	70	55	No	1-10V	IP66
-	HB1IP662579VNSTCE	95	5000	12400	131	70	90	No	1-10V	IP66
-	HB1IP662581VNSTCE	95	5000	11900	125	80	120	No	1-10V	IP66
-	HB1IP662585VNSTCE	95	5000	11100	117	80	55	No	1-10V	IP66
-	HB1IP662589VNSTCE	95	5000	11500	121	80	90	No	1-10V	IP66
-	HB1IP664471VNSTCE	190	4000	26000	137	70	120	No	1-10V	IP66
-	HB1IP664475VNSTCE	190	4000	24500	129	70	55	No	1-10V	IP66
-	HB1IP664479VNSTCE	190	4000	25300	133	70	90	No	1-10V	IP66
-	HB1IP664481VNSTCE	190	4000	23800	125	80	120	No	1-10V	IP66
-	HB1IP664485VNSTCE	190	4000	22000	116	80	55	No	1-10V	IP66
-	HB1IP664489VNSTCE	190	4000	22600	119	80	90	No	1-10V	IP66
-	HB1IP664571VNSTCE	190	5000	25600	135	70	120	No	1-10V	IP66
-	HB1IP664575VNSTCE	190	5000	24300	128	70	55	No	1-10V	IP66
-	HB1IP664579VNSTCE	190	5000	25100	132	70	90	No	1-10V	IP66
-	HB1IP664581VNSTCE	190	5000	24100	127	80	120	No	1-10V	IP66
-	HB1IP664585VNSTCE	190	5000	22500	118	80	55	No	1-10V	IP66
-	HB1IP664589VNSTCE	190	5000	23200	122	80	90	No	1-10V	IP66
-	HB1IP663471DNSTCE	157	4000	21300	136	70	120	No	DALI	IP66
-	HB1IP663475DNSTCE	157	4000	19900	127	70	55	No	DALI	IP66
-	HB1IP663479DNSTCE	157	4000	20600	131	70	90	No	DALI	IP66
-	HB1IP663481DNSTCE	157	4000	19400	124	80	120	No	DALI	IP66
-	HB1IP663485DNSTCE	157	4000	18100	115	80	55	No	DALI	IP66
-	HB1IP663489DNSTCE	157	4000	18800	120	80	90	No	DALI	IP66
-	HB1IP663571DNSTCE	157	5000	21100	134	70	120	No	DALI	IP66
-	HB1IP663575DNSTCE	157	5000	19800	126	70	55	No	DALI	IP66
-	HB1IP663579DNSTCE	157	5000	20400	130	70	90	No	DALI	IP66
-	HB1IP663581DNSTCE	157	5000	19600	125	80	120	No	DALI	IP66
-	HB1IP663585DNSTCE	157	5000	18300	117	80	55	No	DALI	IP66
-	HB1IP663589DNSTCE	157	5000	18900	120	80	90	No	DALI	IP66

Mounting & Accessories

Mounting Options

Image

Accessories

Bracket kit (optional)

Order separately.
Attaches to M12 threaded rod
(rod and nuts not included).

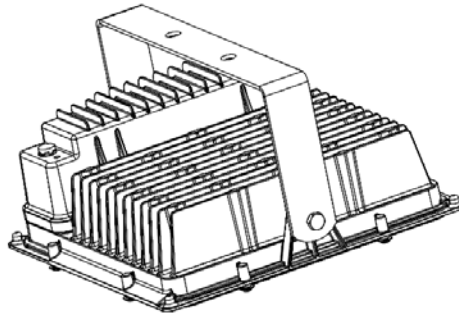

HighBay IP66 fixture Bracket kit
93069190

Suspension holder kit (optional)

Order separately. Price adder per pair.
For suspension cable 1.5 / 3 / 4.5 / 6 m
length versions available.

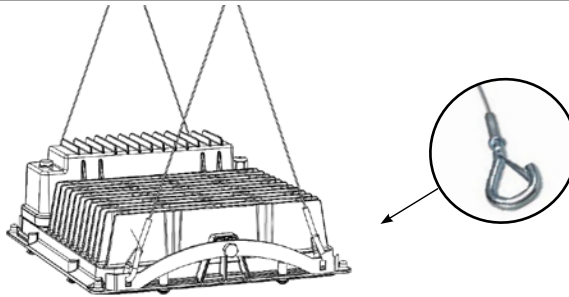

Cable options:
ABHG-YCABLEHOOK1500MMPAIR **13498**
ABHG-YCABLEHOOK3000MMPAIR **13499**
ABHG-YCABLEHOOK4500MMPAIR **13504**
ABHG-YCABLEHOOK6000MMPAIR **13508**

HighBay IP66 fixture
Suspension holder kit
93069191



Dimensions (mm)

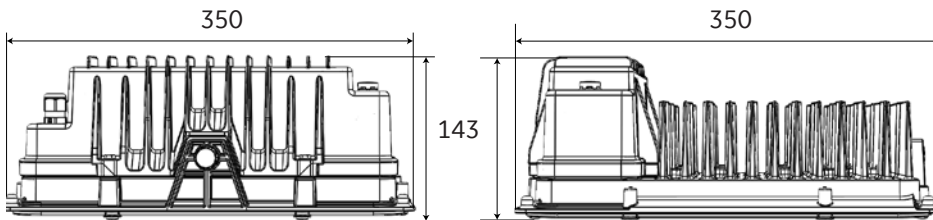

Wattage	Weight
95W	8.4kg
157W	8.2kg
190W	9kg

