

Tetra[®] Contour

LED ARCHITECTURAL SERIES

Product Codes

75521, 75526, 75529, 75541 & 62186

Preparation

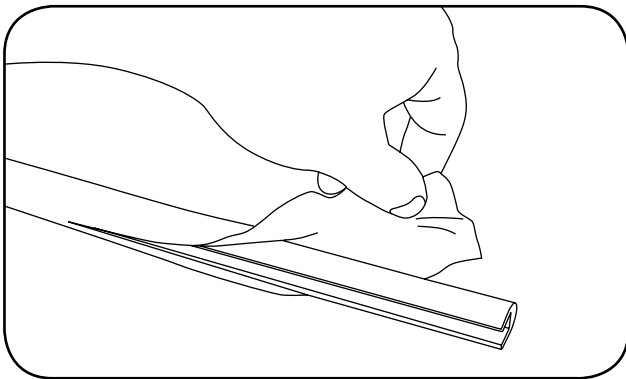

- 1** Remove the protective film from the light guide.

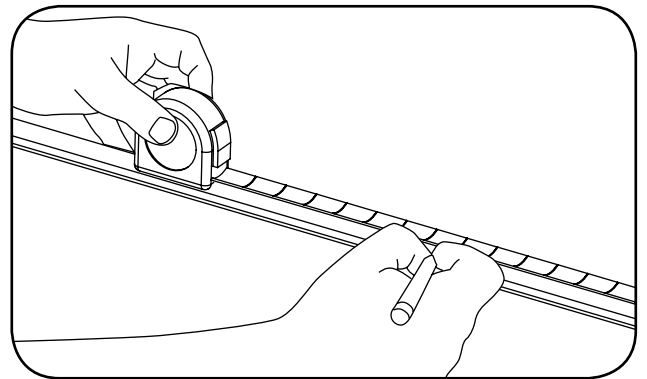

- 2** Mark the light guide at the required length, adding 0.5 in. (13mm) for every 16 in. (406mm) to account for shrinkage during the forming process.

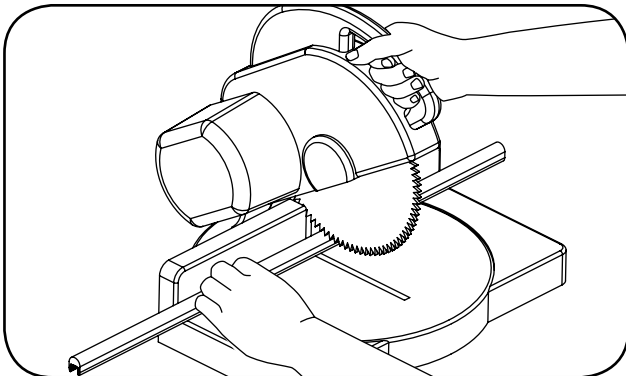

- 3** Cut the light guide to the required length using a hacksaw, chop saw (cross cut or veneer blade only), band saw, or other appropriate plastic cutting tool.

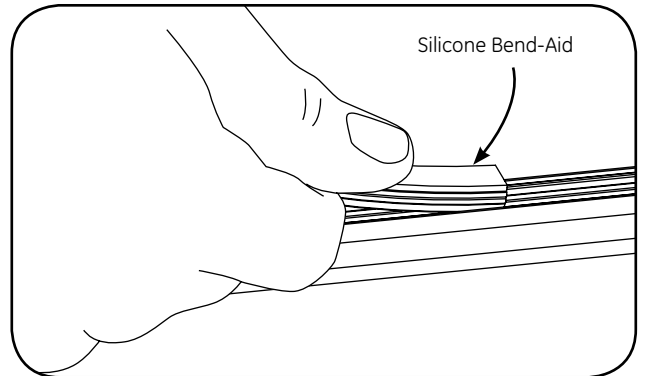

- 4** Fill the entire light guide channel with the GEXNBA Silicone Bend-Aid(s) and press into place. Bend-Aid must be installed prior to heating and forming.

NOTE: The GEXNBA Silicone Bend-Aid is reusable.

CAUTION: DO NOT heat and form the light guide with the light engine installed.



imagination at work

Heating and Forming

For large bends, use either an industrial oven or heating blanket.
 For small bends, use a heat gun.

CAUTION: Avoid direct contact between hot materials and exposed skin or combustibles. Use heat resistant gloves while heating and/or handling any hot materials.

CAUTION: DO NOT use an open flame to heat the light guide.

Bend Type	Minimum Bend Radius
Planar	0.5 in. (13mm)
Inside Corner	1.0 in. (25mm)
Outside Corner	1.5 in. (38mm)

Option A: Large Bends

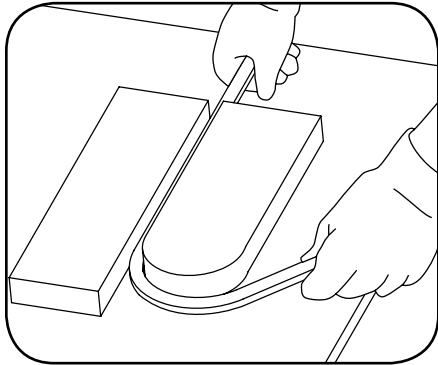

Preheat the heating equipment to 300°F (149°C). Heat light guides approximately 6-15 minutes until soft and pliable. Bend the light guide over a printed pattern, routed template, or use free-forming. A clean flat insulated surface (wood or laminated countertop) will help to prevent twisting or bowing. See the chart above for minimum bend radius guidelines.

Option B: Small Bends

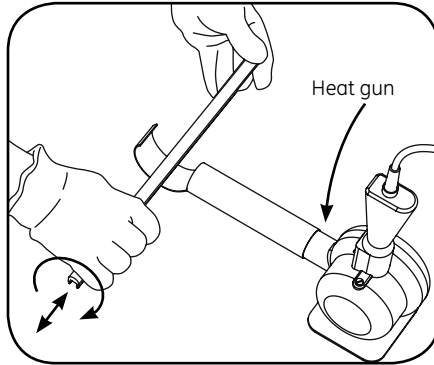

Part 1: Move the section back and forth while rotating about the diameter until it is soft and pliable. Gently bend to the desired angle.

NOTE: It is recommended to use a heat-deflecting shield to distribute the heat evenly.

NOTE: Avoid localized overheating that may result in distortion or damage (i.e. bubbling) of the light guide.

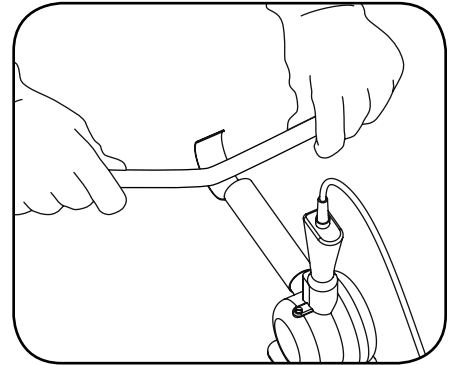

Part 2: The workable forming time is about 2-3 minutes. The light guide must remain in the desired position until completely cooled. See the chart above for minimum bend radius guidelines.

Allow the light guide to cool by natural convection or lightly forced cool air (i.e. fan). Remove the Bend-Aids for reuse. In order to remove any minor surface flaws, perform a light sanding using 400 grit sandpaper. Flared or deformed ends can be trimmed. The light guide is now ready for light engine installation.

NOTE: DO NOT remove the Bend-Aids until the light guide has completely cooled.

NOTE: DO NOT subject heated light guide to freezing or quenching in water.



GE Lighting Solutions • 1-888-MY-GE-LED • www.gelightsolutions.com
 1-888-69-43-533

GE Lighting Solutions is a subsidiary of the General Electric Company. Tetra is a trademark of GE Lighting Solutions. The GE brand and logo are trademarks of the General Electric Company. © 2011 GE Lighting Solutions. Information provided is subject to change without notice. All values are design or typical values when measured under laboratory conditions.